



**ALL TRANSISTOR
FM/AM COMPACT STEREO
MODEL KS-3200H
SERVICE MANUAL**

No. 253

1969

SPECIFICATIONS

CIRCUIT SYSTEM.....all-transistor FM/AM 2 band super-heterodyne with FM multiplex stereo adaptor
TUNING RANGE.....FM : 88~108 MHz
 AM : 530~1,605KHz
INTERMEDIATE FREQUENCY.....FM : 10.7MHz
 AM : 455KHz

TRANSISTORS

Q101 2SC535(B).....FM RF AMP.
 Q102 2SC535(A).....FM MIX.
 Q103 2SC535(A).....FM OSC.
 Q104 2SC460(B).....FM 1st IF AMP.
 Q105 2SC460(B).....AF RF AMP.
 Q106 2SC460(B).....AM CONV.
 Q107 2SC460(B).....FM 2nd IF AMP. & AM 1st IF AMP.
 Q108 2SC460(C).....FM 3rd IF AMP. & AM 2nd IF AMP.
 Q109 2SC460(C).....FM 4th IF AMP.
 Q111 2SC458(D).....MUTING
 Q301 2SC458(B).....19KHz AMP.
 Q302 2SC458(A).....19KHz AMP.
 Q303 2SC458(B).....38KHz
 Q304 2SC458(C).....DC AMP.
 Q601A,B 2SC458LG×2.....PRE. AMP.
 Q021A,B SC458LG(C)×2.....PRE. AMP.
 Q022A,B 2SC458LG(B)×2.....PRE. AMP.
 Q401A,B 2SC458(B)×2.....1st AF AMP.
 Q402A,B 2SC984(C)×2.....2nd AF AMP.
 Q403A,B 2SC984(B)×2.....DRIVER
 Q404A,B 2SA565(B)×2.....DRIVER
 Q405A,B 2SC830×4.....POWER AMP.
 Q406A,B

DIODES

CR101 1N60.....FM LIMIT.
 CR102 1S85.....FM AFC
 CR103 } 1N60×2.....FM LIMIT.
 CR104 }
 CR105 1N60.....AM AGC
 CR106 1N34A.....AM DET.

CR107 1N60(P).....FM RATIO DET.
 CR108 1N60(P).....FM RATIO DET.
 CR109 1N34A.....AM DET.
 CR110 } 1N60×2.....FM DET.
 CR111 }
 CR112 1N60.....SWITCHING
 CR301 } 1N34A×2.....DOUBLER
 CR302 }
 CR303,304 } 1N60(P)×4.....SWITCHING
 CR305,306 }
 CR001 } VO3C×2.....RECTIFIER
 CR002 }
 CR003 AW01-13.....ZENER DIODE
VARISTORS
 VR101, 102 } HV-23×3.....VOLTAGE STAB.
 VR301 }
 VR401A,B } HV-23×6.....TEMP. COMPENSATOR
 VR402A,B }
 VR403A,B }
LOUDSPEAKER.....8"×2 (Woofer)
 2½"×2 (Tweeter)
AUDIO OUTPUT.....30W×2 Music power
POWER SUPPLY.....AC 120V, 60Hz
POWER CONSUMPTION.....120W
ANTENNA.....FM Line cord and external antenna
 AM Ferrite-core antenna
SENSITIVITY.....FM 3μV AM 50μV/m (Max.)
 FM 5μV AM200μV/m
 (practical)
TERMINALS.....Stereo headphone jack attached
DIMENSIONS.....Radio 5¼"(H)×19½"(W)×14¼"(D)
 (13.3×48.6×37.6cm)
 Speaker box 18½"(H)×10¼"(W)
 ×7⅞"(D)
 (46.0×26.0×20.0cm)
WEIGHT.....Radio 31 lbs. 4 oz. (14.2kg)
 Speaker box 11 lbs.×2 (5kg×2)

CONTROLS

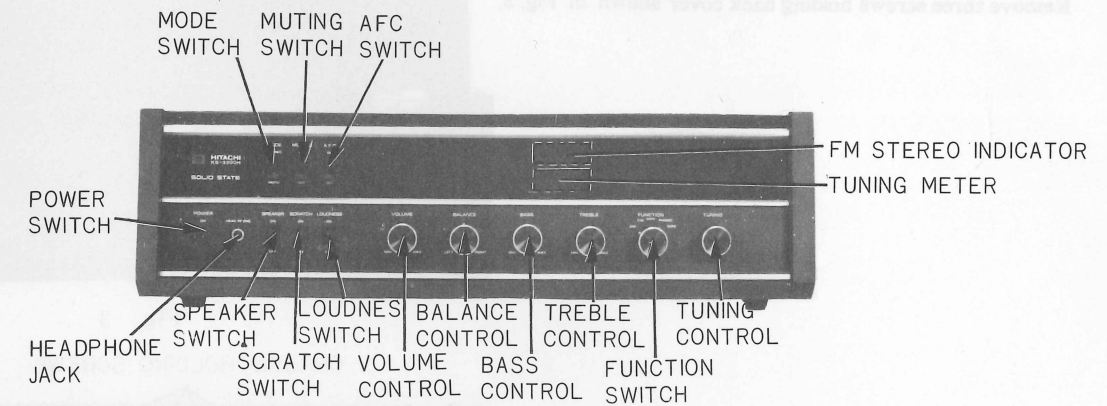

Fig. 1

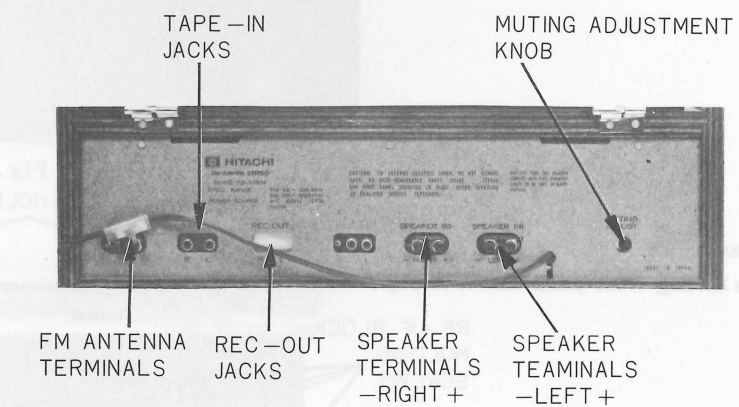

Fig. 2

DISASSEMBLY

1. Removal of back cover

Remove three screws holding back cover shown in Fig. 3.

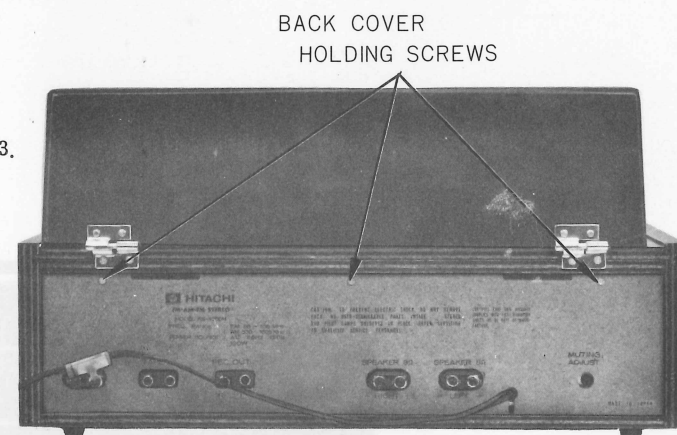

Fig. 3

2. Removal of chassis.

After pulling out the six knobs and a power switch knob, remove four screws holding chassis and take out the chassis shown in Fig. 4.

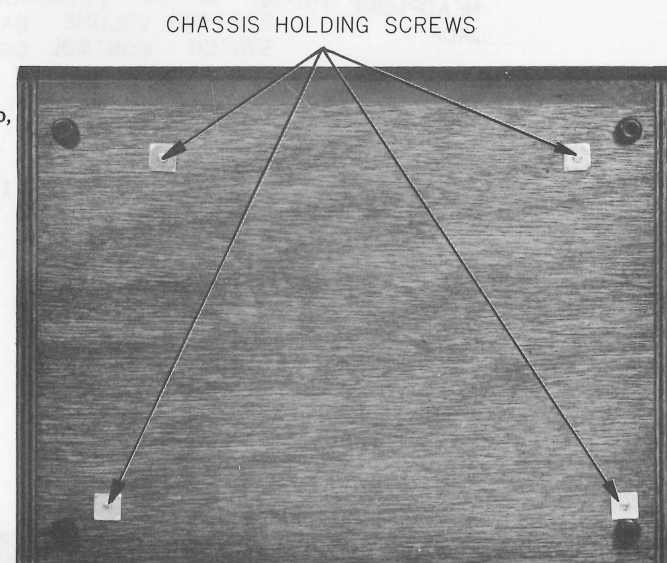

Fig. 4

3. Removal of front panel.

Remove five screws holding front panel shown in Figs. 5 and 6.

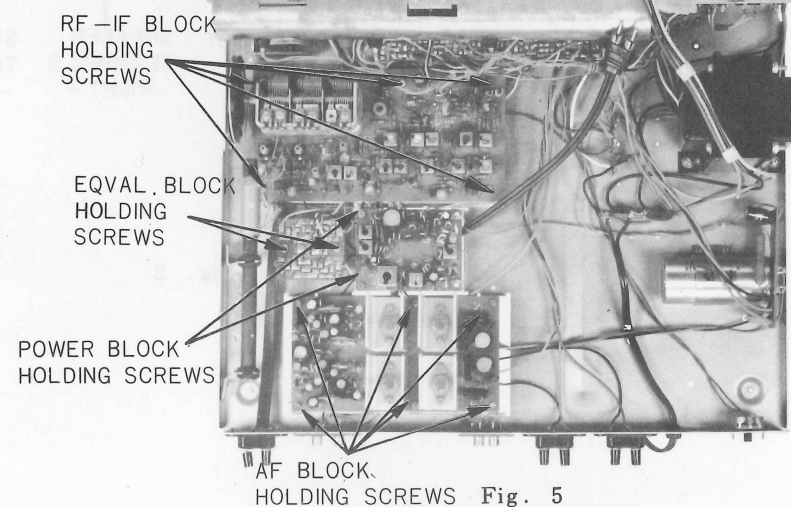

Fig. 5

4. Removal of dial lamp cover.

Remove two screws holding dial lamp cover shown in Fig. 7.

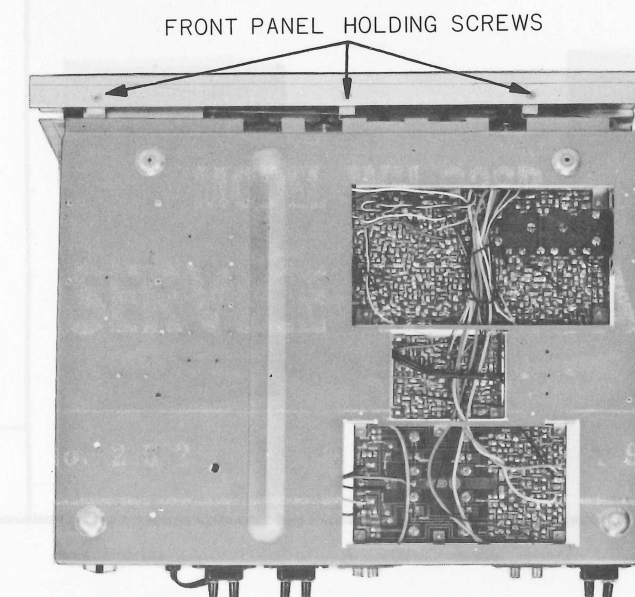

Fig. 6

5. Removal of indicator.

Remove two screws holding indicator shown in Fig. 7.

DIAL LAMP COVER HOLDING SCREWS(2) INDICATOR HOLDING SCREWS DIAL LAMP COVER HOLDING SCREWS(1)

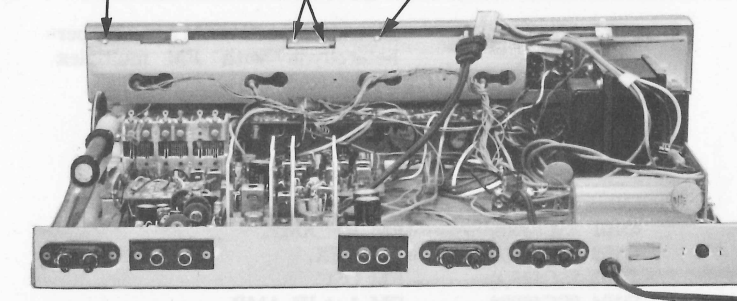

Fig. 7

6. Removal of circuit board.

Remove five screws holding RF-IF block, six screws holding AF block, two screws holding power block and two screws holding equalizer block shown in Fig. 5. Remove four nuts holding rotary switches shown in Fig. 8.

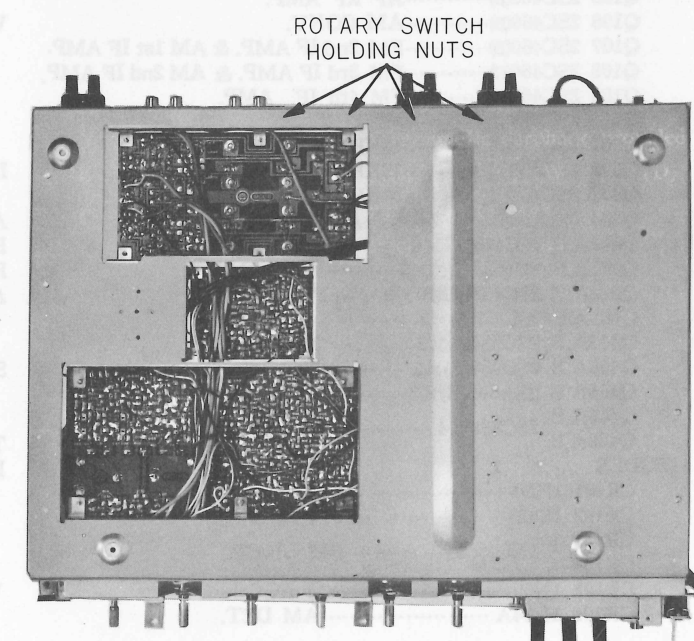

Fig. 8

DIAL CORD RESTRINGING

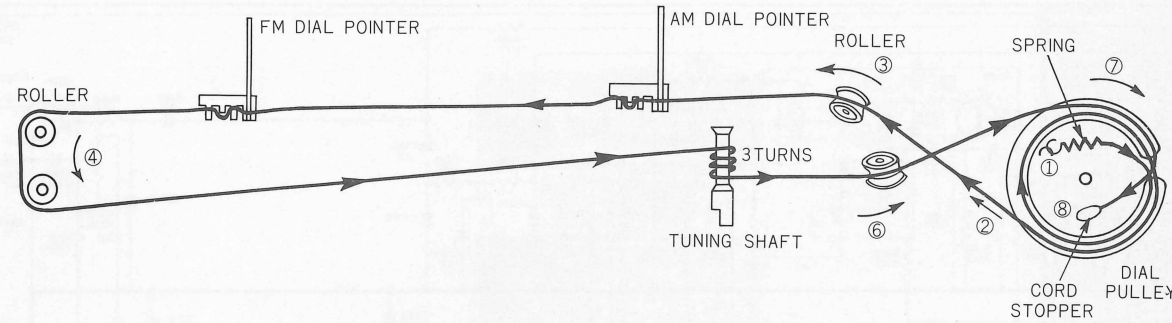

Fig. 9

INTERNAL VIEW

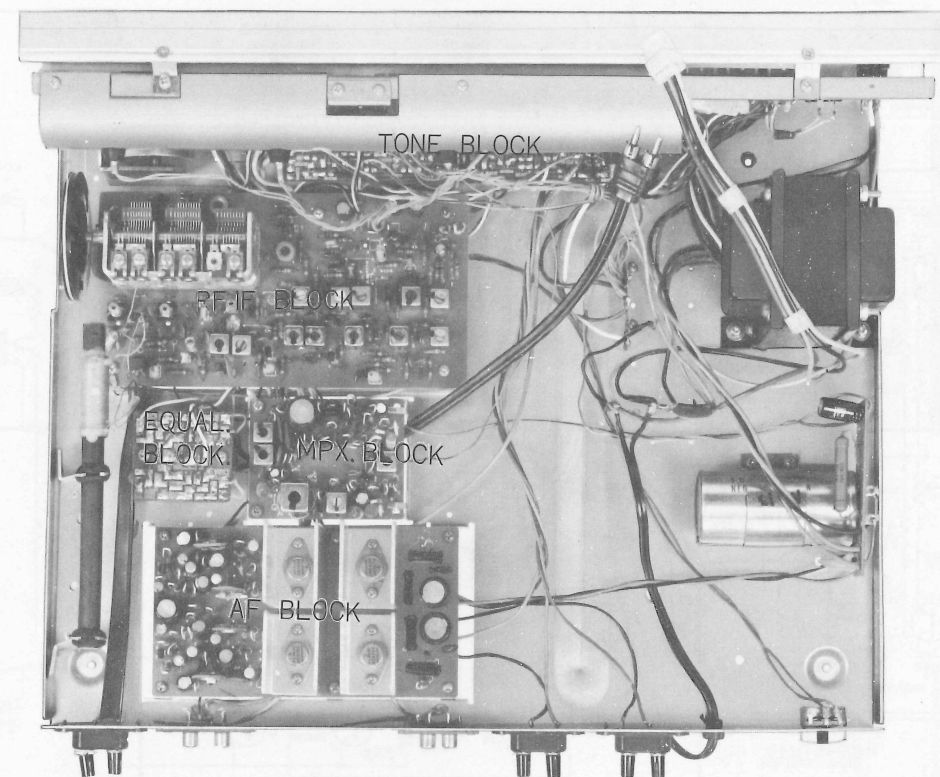
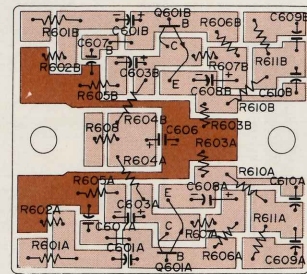

Fig. 10

REPLACEMENT PARTS

Symbol No.	Stock No.	Description	Symbol No.	Stock No.	Description
CAPACITORS:					
C 001	0245408	Ceramic	C 154	0275113	Same as C134
C 002	0245408	Same as C001	C 155	0275111	Same as C132
C 003	0259707	Electrolytic	C 156	0252513	Electrolytic
C 004	0252631	Electrolytic	C 157	0275113	Same as C134
C 010	0257039	Electrolytic	C 158	0275111	Same as C132
C021A,B	0252513	Electrolytic	C 159	0275115	Mylar
C 022	0252532	Electrolytic	C 160	0275113	Same as C134
C023A,B	0252223	Electrolytic	C 161	0245017	Same as C105
C024A,B	0252513	Same as C021A	C 162	0245017	Same as C105
C025A,B	0274111	Mylar	C 163	0245017	Same as C105
C026A,B	0275115	Mylar	C 164	0248669	Ceramic
C027A,B	0275113	Mylar	C 165	0248641	Same as C121
C028A,B	0252513	Same as C021A	C 166	0248724	Same as C133
C029A,B	0252513	Same as C021A	C 167	0248724	Same as C133
C030A,B	0275111	Mylar	C 168	0252513	Same as C156
C031A,B	0274115	Mylar	C 169	0248724	Same as C133
C032A,B	0275115	Same as C026A,B	C 170	0248724	Same as C133
C033A,B	0275113	Same as C027A,B	C 171	0276111	Mylar
C034A,B	0276113	Mylar	C 172	0275113	Same as C134
C035A,B	0248716	Ceramic	C 173	0275113	Same as C134
C037A,B	0274111	Same as C025A,B	C 174	0252531	Electrolytic
C 052	0245408	Ceramic	C 181	0274111	Mylar
C 101	0248710	Ceramic	C 182	0252225	Electrolytic
C 102	0248645	Ceramic	C 186	0248643	Same as C109
C 103	0248706	Ceramic	C 187	0248643	Same as C109
C 104	0248646	Ceramic	C 188	0275113	Mylar
C 105	0245017	Ceramic	C 189	0252525	Electrolytic
C 106	0245017	Same as C105	C 301	0274111	Mylar
C 107	0245017	Same as C105	C 302	0248696	Ceramic
C 108	0248706	Same as C103	C 303	0248694	Ceramic
C 109	0248643	Ceramic	C 304	0248736	Ceramic
C 110	0244016	Ceramic	C 305	0252513	Electrolytic
C 111	0245017	Same as C105	C 306	0252521	Electrolytic
C 112	0245017	Same as C105	C 307	0221351	Polystyrol
C 113	0248643	Same as C109	C 309	0252535	Electrolytic
C 114	0245017	Same as C105	C 310	0221351	Same as C307
C 115	0244016	Same as C110	C 311	0221351	Same as C307
C 116	0245716	Ceramic	C 312	0252225	Electrolytic
C 117	0246430	Ceramic	C 313	0221339	Polystyrol
C 118	0246428	Ceramic	C 314	0274111	Same as C301
C 119	0248645	Same as C102	C 315	0274111	Same as C315
C 120	0245017	Same as C105	C 316	0274111	Same as C315
C 121	0248641	Ceramic	C 317	0274111	Same as C315
C 122	0245018	Ceramic	C 318	0274111	Same as C315
C 123	0245019	Ceramic	C 319	0274111	Same as C315
C 124	0245018	Same as C122	C 320	0275113	Mylar
C 125	0245017	Same as C105	C 321	0275113	Same as C320
C 126	0245017	Same as C105	C 322	0275115	Mylar
C 127	0248645	Same as C102	C 323	0275115	Same as C322
C 128	0245017	Same as C105	C 324	0275113	Same as C320
C 129	0245017	Same as C105	C 325	0275115	Same as C322
C 130	0248646	Same as C104	C401A,B	0252513	Electrolytic
C 131	0248645	Same as C102	C 402	0252532	Electrolytic
C 132	0275111	Mylar	C403A,B	0252231	Electrolytic
C 133	0248724	Ceramic	C404A,B	0252513	Same as C401A,B
C 134	0275113	Mylar	C405A,B	0252231	Same as C403A,B
C 135	0248645	Same as C102	C406A,B	0248726	Ceramic
C 136	0275113	Same as C134	C 407	0252625	Electrolytic
C 137	0275115	Mylar	C408A,B	0248734	Ceramic
C 138	0275111	Same as C132	C409A,B	0252635	Electrolytic
C 139	0248724	Same as C133	C410A,B	0275115	Mylar
C 140	0241868	Ceramic	C601A,B	0252513	Electrolytic
C 141	0221339	Styrol	C603A,B	0252513	Same as C601A,B
C 142	0275113	Same as C134	C606A,B	0252531	Electrolytic
C 143	0274115	Same as C137	C607A,B	0248734	Ceramic
C 144	0274111	Mylar	C608A,B	0252513	Same as C601A,B
C 145	0275113	Same as C134	C609A,B	0274114	Mylar
C 146	0248641	Same as C121	C610A,B	0274116	Mylar
C 147	0275113	Same as C134	CT101		
C 148	0248643	Same as C109	CV101~	0281557	Variable
C 149	0248650	Ceramic	106		
C 150	0274111	Same as C144	CT102	0281557	Same as CT1
C 151	0275113	Same as C134	CT103	0283113	Trimmer
C 152	0275113	Same as C134	CT104	0281557	Same as CT1
C 153	0248643	Same as C109			

CIRCUIT BOARD DIAGRAM



(EQUAL. BLOCK)

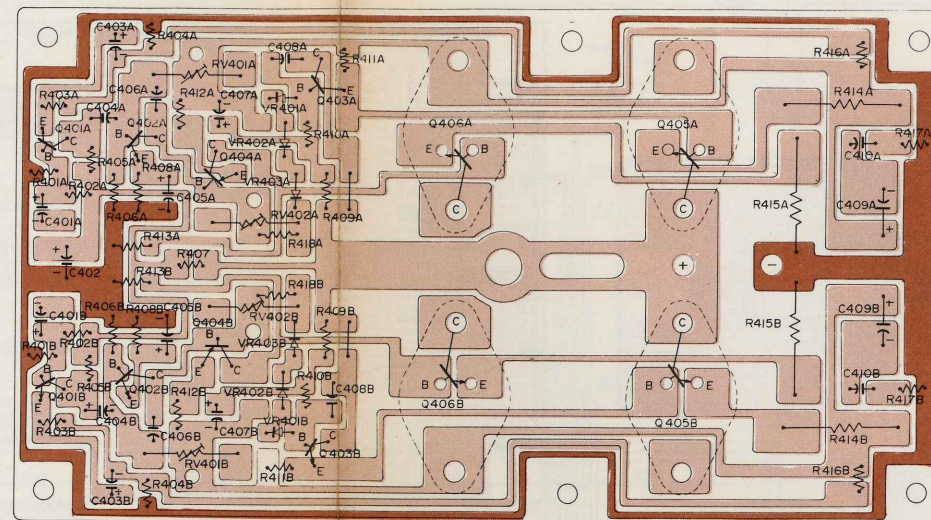

(AF BLOCK)

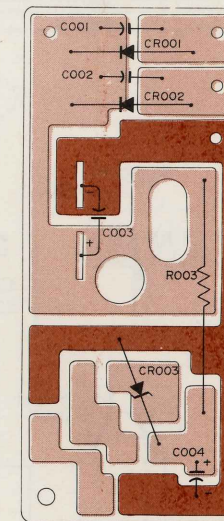

(POWER BLOCK)

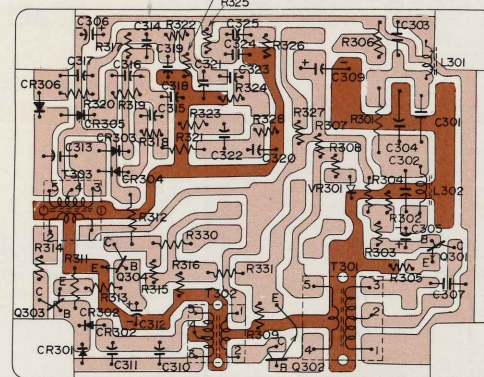

(MPX. BLOCK)

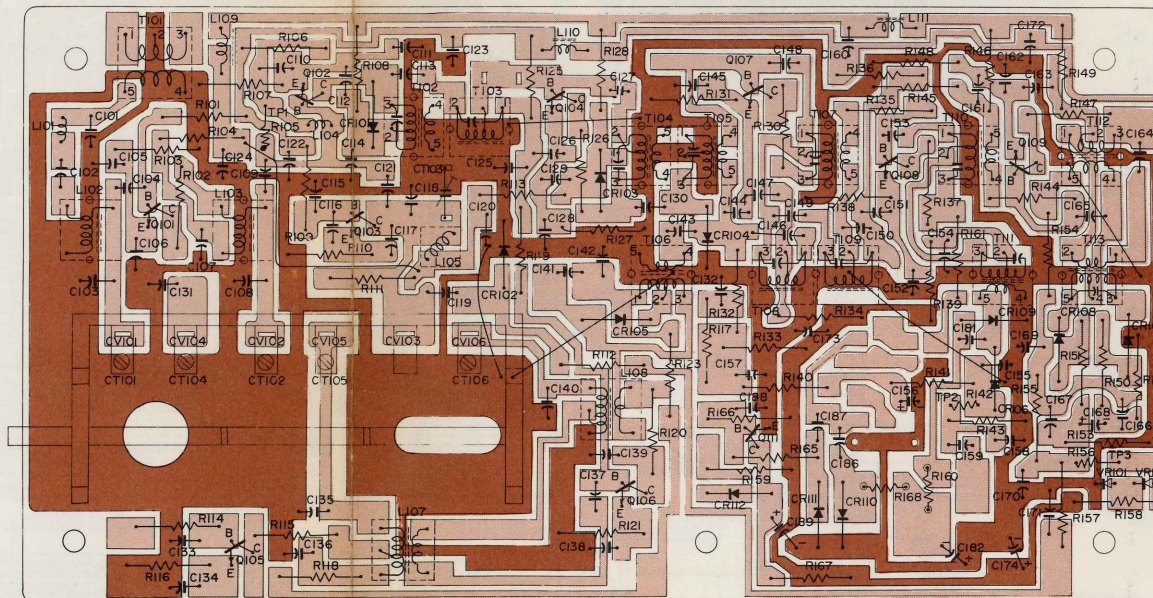

(RF - IF BLOCK)

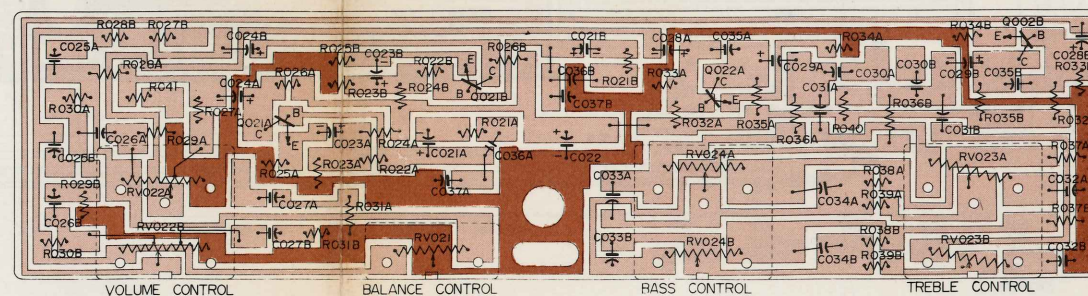

VOLUME CONTROL BALANCE CONTROL BASS CONTROL TREBLE CONTROL

(TONE BLOCK)

WIRING DIAGRAM

